

HARDIN
MARINE

11 Industry Dr. Palm Coast, FL 32137
386-445-2500 / FAX 386-445-1122

PART NO.

125-S900

TITLE:

9 BOLT WHEEL ADAPTER

www.hardin-marine.com

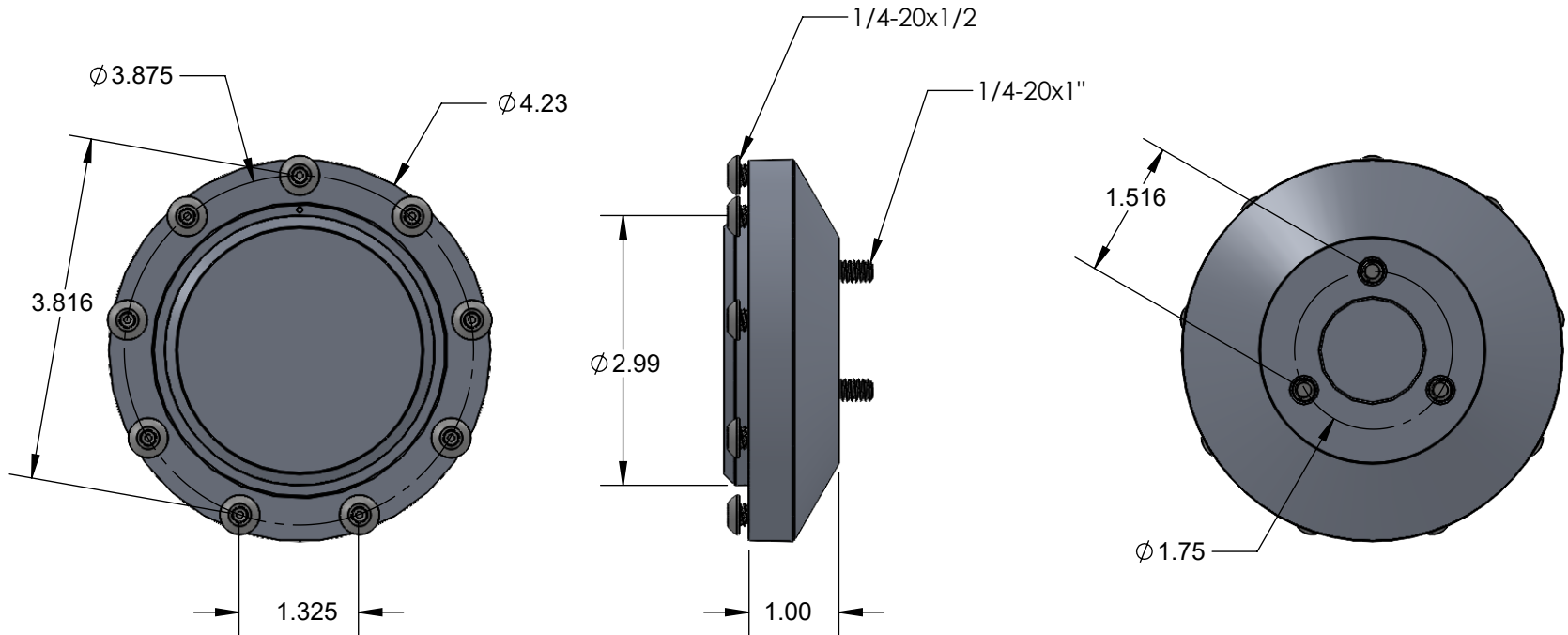

THIS DRAWING IS CONFIDENTIAL AND IS SUPPLIED ON EXPRESS CONDITION THAT IT SHALL NOT BE LENT, COPIED OR DISCLOSED TO ANY OTHER PERSON OR USED FOR ANY OTHER PURPOSE WITHOUT WRITTEN CONSENT OF HARDIN MARINE INC.. BREACH OF THIS CONTRACT WILL HOLD AND IT'S PRINCIPALS LIABLE FOR LOSS AND DAMAGES.