

HARDIN MARINE 11 Industry Dr. Palm Coast, FL 32137  
386-445-2500 / FAX 386-445-1122

PART NO.  
625-5176

TITLE:  
10" ROUND 4500 FLAME ARRESTOR

[www.hardin-marine.com](http://www.hardin-marine.com)

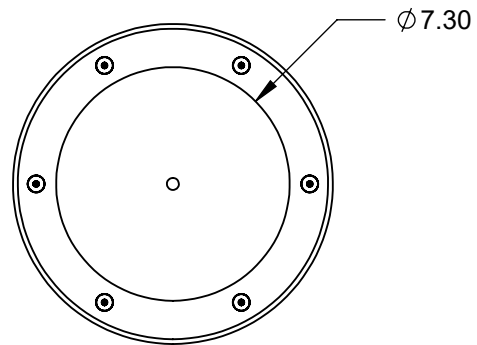
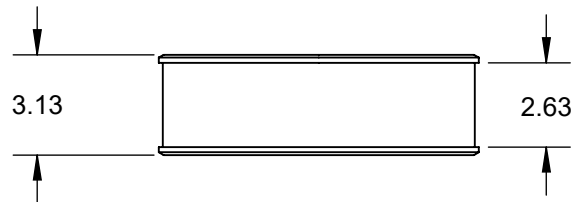
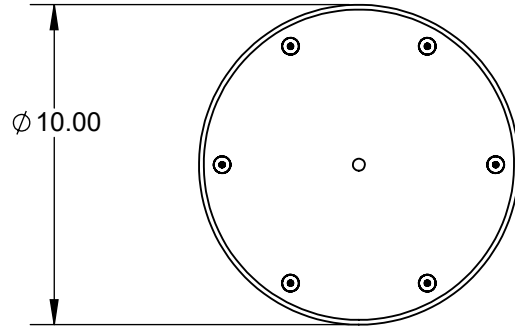
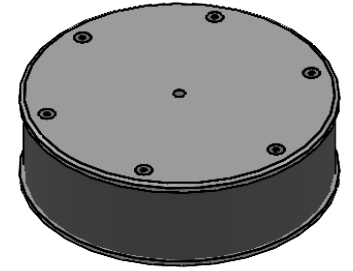

THIS DRAWING IS CONFIDENTIAL AND IS SUPPLIED ON EXPRESS CONDITION THAT IT SHALL NOT BE LENT, COPIED OR DISCLOSED TO ANY OTHER PERSON OR USED FOR ANY OTHER PURPOSE WITHOUT WRITTEN CONSENT OF HARDIN MARINE INC.. BREACH OF THIS CONTRACT WILL HOLD ..... AND IT'S PRINCIPALS LIABLE FOR LOSS AND DAMAGES.