

# OWNER'S MANUAL

1998-2003 MERCUISER 7.4 MPI

## **PROCHARGER**<sup>®</sup> *Marine*

*Centrifugal Supercharger Systems*

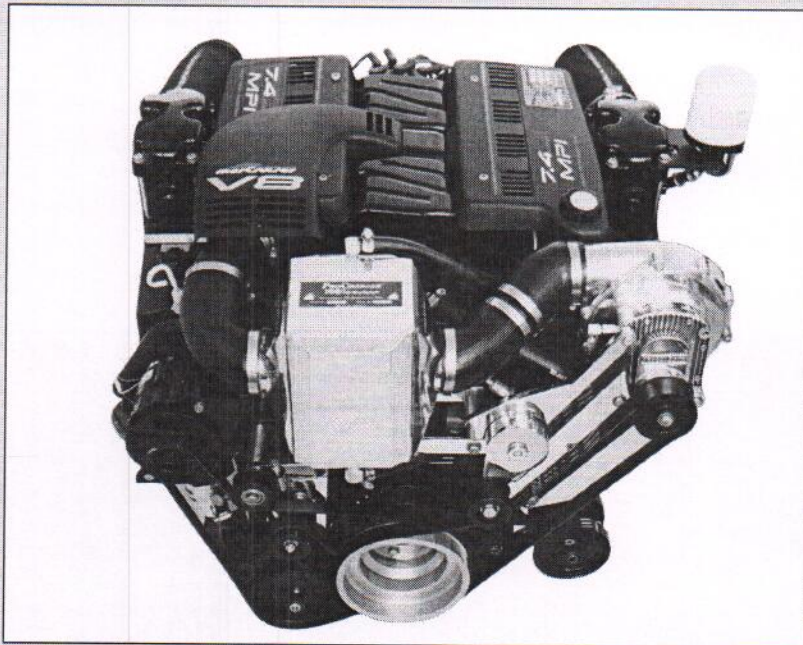

*The Intercooled Supercharging Experts!*<sup>®</sup>



ACCESSIBLE TECHNOLOGIES, INC.  
© 2006 ATI, ALL RIGHTS RESERVED  
1MD181-NN

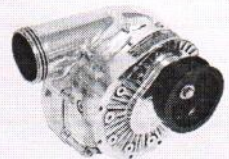

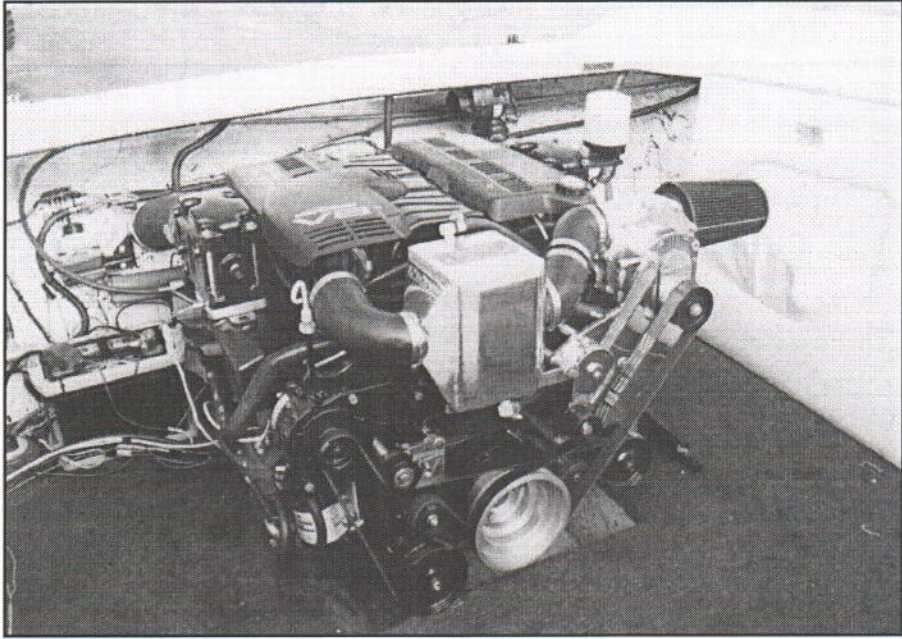

## **INSTALLATION OVERVIEW**

Congratulations on the purchase of your ProCharger® centrifugal supercharger system, and welcome to the world of centrifugal supercharging. You are now the owner of the most powerful and reliable supercharger system available, and the latest technology in supercharging!

This Owner's Manual contains the following sections:

- **INTRODUCTION**
- **INSTALLATION INSTRUCTIONS**
- **OPERATION AND MAINTENANCE**
- **WARRANTY**

If you are performing the installation of this system and this is your first ProCharger installation, you will likely benefit from reading the entire installation instructions prior to proceeding, and then reviewing each section as you go. If you are familiar with supercharging, remember that centrifugal supercharging is different from roots supercharging, and the same rules do not apply, primarily due to the unparalleled efficiency of the ProCharger, and the vastly cooler intake temperatures that result, especially when intercooled.

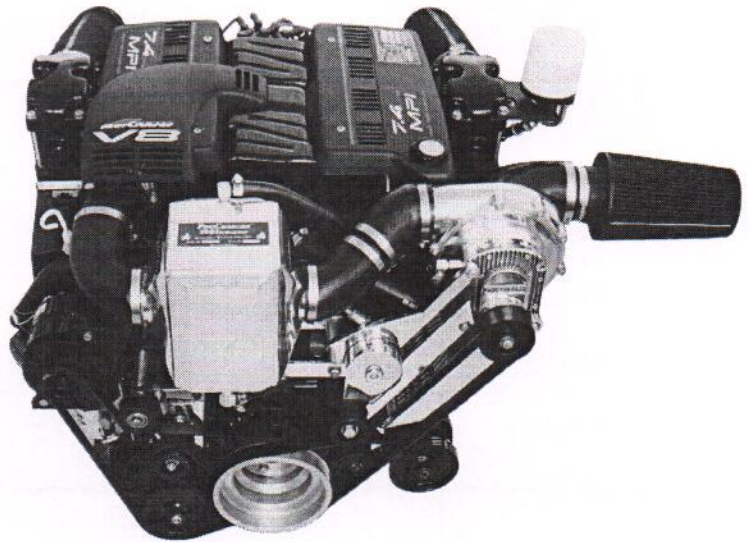

- A. OIL DRAIN SETUP**
- B. ENGINE PREPARATION**
- C. OIL FEED SETUP**
- D. PROCHARGER AND ENGINE ACCESSORY INSTALLATION**
- E. AIR INLET AND INTERCOOLER TUBING INSTALLATION**
- F. WATER LINE INSTALLATION**
- G. FUEL SYSTEM INSTALLATION**
- H. INSTALLATION REVIEW AND SAFETY CHECK**
- I. GENERAL TUNING AND THEORY**
- J. OPERATION AND MAINTENANCE, SPECIAL NOTES FOR SC APPLICATIONS**



## IMPORTANT INFORMATION FOR RELIABLE OPERATION!

**USE MINIMUM 91 OCTANE FUEL AT ALL TIMES.**

**MERCUISER EFI/MPI REV LIMITER LIMITS RPM BY CUTTING OFF FUEL, WHICH CAN CAUSE A DANGEROUS LEAN CONDITION. ENSURE THAT BOAT IS PROPPED SO THAT MAXIMUM RPM IS BELOW FACTORY REV LIMITER. REPEATEDLY BUMPING/RIDING REV LIMITER CAN RESULT IN SERIOUS ENGINE DAMAGE.**

Torque Specification Chart	 Grade 5 Torque (lb. ft.)			 Grade 8 Torque (lb.ft.)		
	Thread Size					
1/4-20	11	8	7	16	12	10
1/4-26	13	10	8	18	14	11
5/16-18	23	17	14	33	25	20
5/16-24	26	19	15	36	27	22
3/8-16	41	31	25	58	44	35
3/8-24	47	35	28	66	49	39
7/16-14	66	49	40	93	70	56
7/16-20	74	55	44	104	78	62
1/2-13	101	75	60	142	106	85
1/2-20	113	85	68	160	120	96

## INSTALLATION OVERVIEW

For best results we recommend that you review the installation instructions beforehand, and follow the installation instructions closely and in sequence. A detailed packing list is provided (inside box) to help you identify the components of your ProCharger Marine system. The following tools will be required to install your ProCharger Marine supercharger system:

### REQUIRED TOOLS & SUPPLIES

- 3/8" SOCKET SET (STANDARD & METRIC)
- 1/2" SOCKET SET (STANDARD & METRIC)
- SCREWDRIVER SET
- OPEN END WRENCH SET (STANDARD & METRIC)
- RAZOR BLADE OR CARPET KNIFE
- ADJUSTABLE WRENCH
- NUT DRIVER SET
- 8 SPARK PLUGS\*\*
- SPARK PLUG SOCKET\*\*
- OIL FILTER<sup>1</sup>
- 9 QUARTS ENGINE OIL (STRAIGHT 40W AS RECOMMENDED BY MERCUISER)<sup>1</sup>
- HEAVY GREASE\*<sup>1</sup>
- SILICONE SEALER\*<sup>1</sup>
- LARGE HAMMER\*<sup>1</sup>
- 3/8" NPT TAP\*<sup>1</sup>
- 9/16" TAPERED PUNCH\*<sup>1</sup>
- CENTER PUNCH\*<sup>1</sup>
- PLIER SET
- WIRE CUTTERS
- OIL FILTER WRENCH<sup>1</sup>

You should also have the following gauges available to properly check the finished installation and monitor your vessel's performance (especially for high performance applications):

- boost/vacuum gauge (plumbed to intake manifold)
- fuel pressure gauge (0-100 psi) (plumbed to ATI fuel pressure regulator)

Both gauges should be of a type that can be read from the cockpit while performing a W.O.T. performance test. Cockpit-mounted gauges are preferable, although use of a shop fuel pressure gauge (which has a hose long enough to be read during testing) is an option.

The motor on which the ProCharger is installed should have stock compression. If your engine has been modified in any way, please check with ATI or your dealer before proceeding. This supercharger system is intended for use on strong, well maintained engines. Installation on a worn or troublesome engine should be reconsidered. **Accessible Technologies is not responsible for damage to an engine.**



**Warning: Motor and propeller should be configured so that maximum speed does not exceed boat manufacturer's recommendations for your hull.**

Note: There are minor variations in Mercruiser motors across model years (such as water hose routing for coolers) which may not *specifically* be addressed in these installation instructions. Please contact an ATI service technician should you have any questions.

\* if oil pan does not already have oil return fitting

\*\*if current plugs have more than 100 hours, or are more than 1 yr old

<sup>1</sup>Not required for Self Contained (SC) Applications

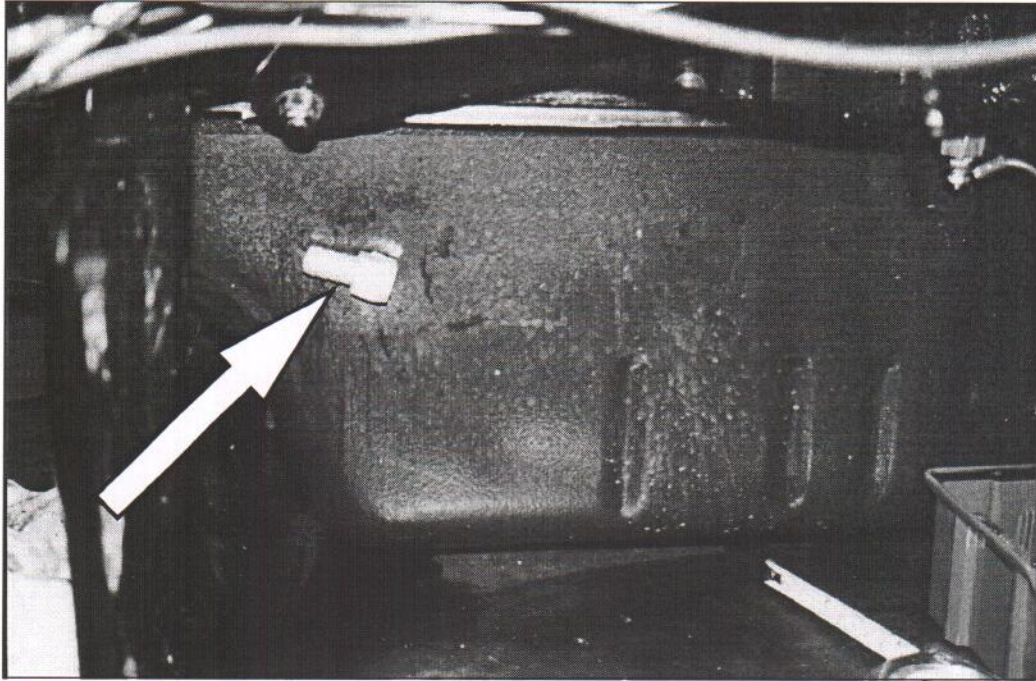

**FIGURE A1**  
**OIL DRAIN FITTING LOCATION AND ORIENTATION**  
**FITTING SHOULD POINT FORWARD, ANGLED SLIGHTLY UPWARD**

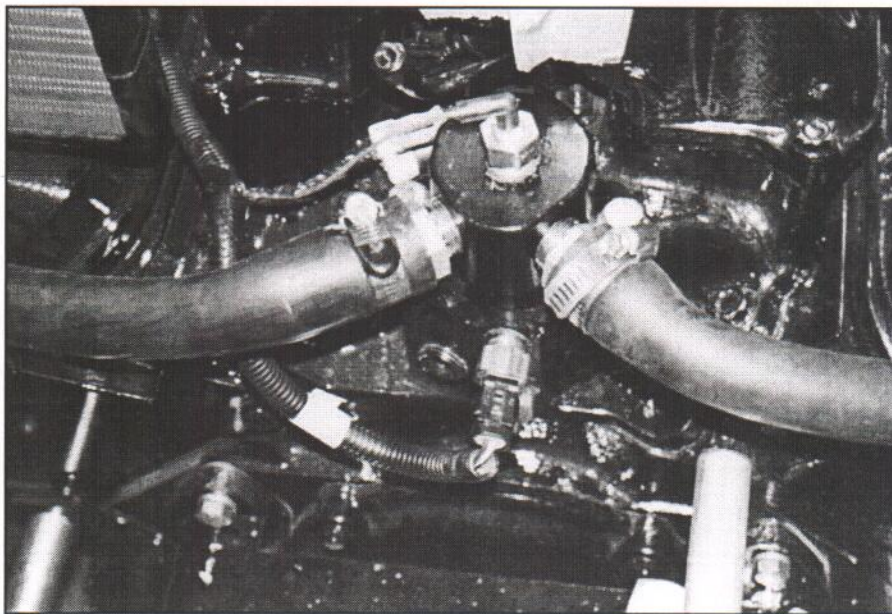

**FIGURE B1**  
**THERMOSTAT HOUSING INSTALLATION**

# INSTALLATION INSTRUCTIONS

## **A. OIL DRAIN SETUP (OMIT FOR SC SYSTEMS)**

*Completion of this section will establish a fitting for the oil return line, which drains oil from the ProCharger into the engine oil pan*

### **DESCRIPTION AND OPERATION**

The main components consist of the oil drain fitting and oil return line. The oil return line is routed from the ProCharger to the oil pan. The drain fitting is installed in the oil pan via either a stock threaded hole or one that must be created. **This is a gravity feed system; the oil return line must be kink free and downhill the entire length, and should drain into the pan above the oil level line.**

1. Remove stock hardware/accessories as needed to gain access to the port side of the oil pan.
2. Punch (Don't drill; punching produces no shavings and leaves a lip for threading) a small pilot hole 1" behind the fourth bolt hole from the front on the port side of the pan and 3" down from the pan flange. Stepping up punch sizes sequentially, enlarge pilot hole to approximately 9/16". Use as short of punch as possible (approx. 1" penetration). For offshore engine mounts: punch and tap the drain hole 1/2" in front of second oil pan bolt and 2 1/2" down from the flange.
3. Pack a 3/8" NPT tap with grease and tap hole. (FYI: 3/8" NPT refers to the pipe's inner diameter). Wipe grease and foreign matter from hole.
4. Using silicone sealer, install the supplied oil return fitting into the pan.
5. Attach the oil return line to the fitting and secure with clamp. Perform an oil and filter change at this point. After initially draining the oil, pour approximately 1/2 quart of oil down the drain line to flush any residue from inside of pan, then continue with oil change normally.
6. Before-installing the fuel pump assembly, see para. G regarding modifications to this assembly.

## **B. ENGINE PREPARATION**

*Completion of this section will configure the Mercruiser motor for installation of the ProCharger system components.*

1. Remove the accessory drive belt tensioner bracket, power steering brackets, oil cooler, water pump, and crankshaft pulley from the front of the engine.
2. Disconnect water lines attached to the thermostat housing assembly. Remove the thermostat housing assembly from the top front of the intake manifold. Remove sending units from housing.
3. Remove the brass fitting from the front (facing forward) of the intake manifold. Install the supplied 1/2"-3/8" NPT bushing into the hole in front of intake manifold previously occupied by fitting. Install sending unit from stock Mercruiser thermostat housing into bushing.
4. Install the ATI provided thermostat housing using the supplied gasket and bolts. Do not install a thermostat! Install second sending unit from stock Mercruiser thermostat housing into top of supplied thermostat housing. See figure B1.
5. If not already plugged off, remove fittings from top front of exhaust manifolds. Install supplied 3/4" NPT plugs.

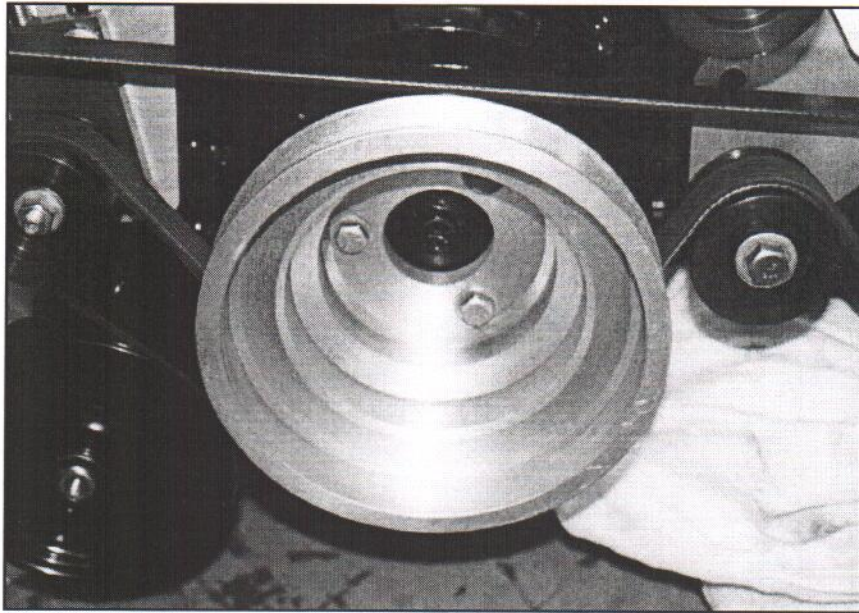

**FIGURE B2**  
**CRANK PULLEY INSTALLATION**

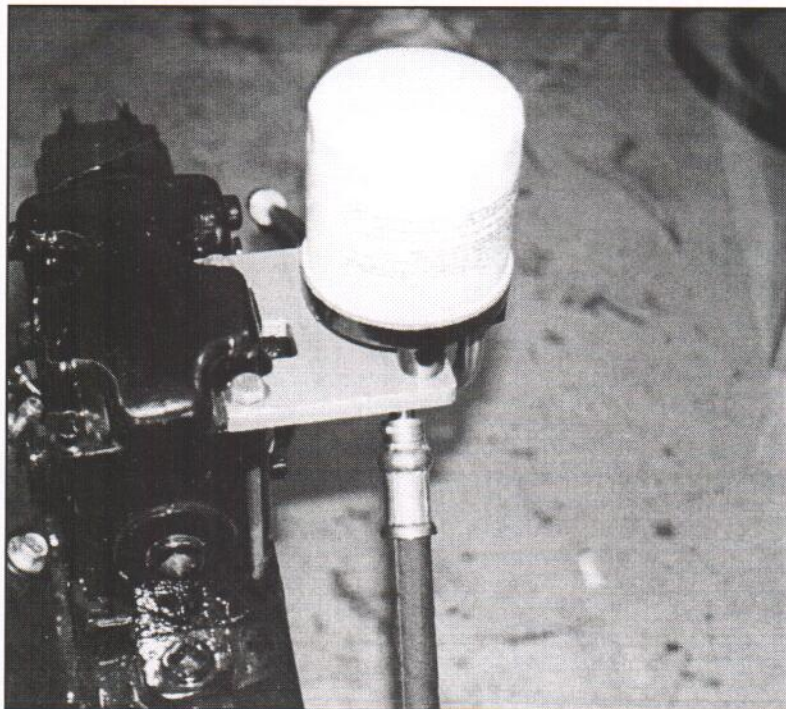

**FIGURE C1**  
**OIL FILTER RELOCATION**



6. The oil cooler will need to be relocated to the back of the motor on the port side. Remove the two oil fittings from the oil cooler body. Switch the short line formerly between the oil cooler and oil filter housing with the line running between the oil filter adaptor on the rear of the engine block and the oil cooler.
7. Install the supplied crossover tube onto the front of the engine using the provided gaskets. Use 3/8" x 1" bolts, leaving the lower left hand bolt hole (as viewed from the front of the engine) open.
8. Position the oil cooler on the back, port side of the engine vertically with the inlet up. Using the stock bracket, attach the cooler to the outboard-most hole in the head. Cut out a section of the water hose which runs from the power steering cooler on the back of the motor to the fuel cooler; large enough to fit the oil cooler. Clamp the hose ends onto the oil cooler. Reconnect the oil lines making sure that none of the oil lines are kinked or twisted.
9. Use the supplied 90° rubber elbow and metal connector to connect the fuel cooler to the fitting on the crossover tube installed in step 7. Clamp all connections securely.
10. Install the supplied crankshaft pulley using the supplied 3/8" x 1.5" bolts as shown in Figure B2.
11. On the port side of the upper intake manifold is a barb fitting attached to the PCV hose. Remove the hose from the fitting and the PCV valve. Remove the fitting from the manifold and install supplied plug.
12. Remove the nut on the starboard side which helps hold the alternator bracket to the engine. Remove the stud from the head and discard.

### **C. OIL FEED SETUP (OMIT FOR SC SYSTEMS)**

*Completion of this section will allow establishment of an oil feed line from the engine to the ProCharger for oil mist lubrication of bearings and gears.*

#### **DESCRIPTION AND OPERATION**

The main components consist of the oil feed bushing, elbow, and oil feed line. The oil feed bushing and elbow are installed in the vacant feed port on the oil filter housing, and provide an oil supply port for the feed line. The oil supply at this location is just downstream of the oil filter. The oil supply is used to supply filtered, high pressure oil to the ProCharger bearings and gears.

1. On the front port side of the engine block, right above the oil pan is a 1/4" NPT plug. Remove this plug. Insert the 1/4" MPT - 1/8" FPT bushing into the hole.
2. Connect the oil feed line to the 1/4" MPT - 1/8" NPT bushing. **Do not use Teflon™ tape or sealant on the fitting**, as this could block the ProCharger oil inlet and damage the precision bearings inside the ProCharger, voiding your warranty.
3. Remove the oil lines from the oil filter housing. Remove the oil filter housing from it's bracket. Attach the supplied oil filter bracket to the outer port side outboard exhaust riser bolts. Attach the oil filter housing to the bracket with the tabs on the underside of the bracket with the filter side up. Pull the oil line out from beside the computer box. Run the line back to the relocated oil filter housing. Attach the oil line from the oil cooler.



**FIGURE D1**

**REAR POWER STEERING BRACKET ORIENTATION**

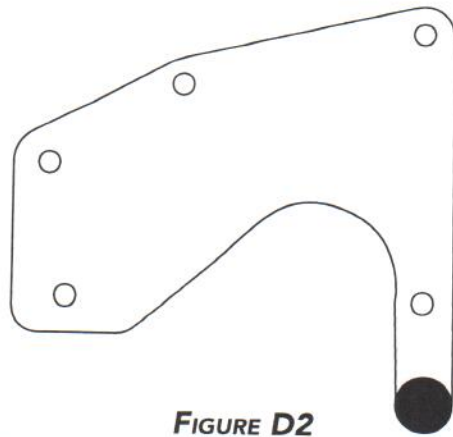

**FIGURE D2**

**FRONT POWER STEERING BRACKET ORIENTATION**

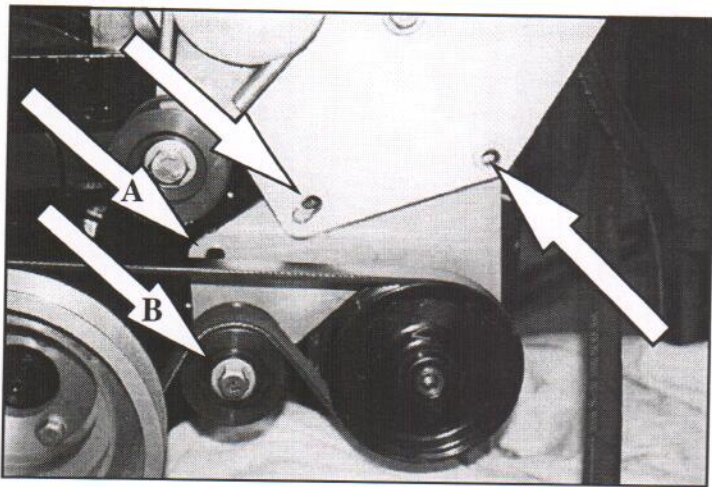

**FIGURE D3**

**FRONT POWER STEERING BRACKET MOUNTING LOCATIONS**

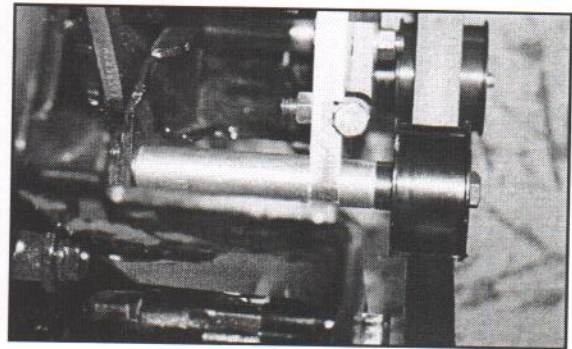

**FIGURE D4**

**SPACER AND IDLER ASSEMBLY**

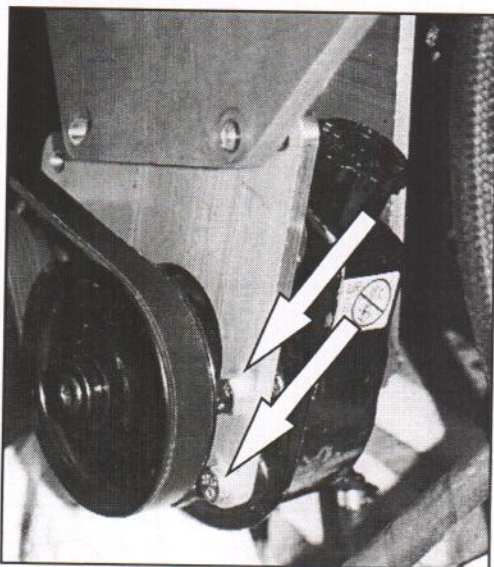

**FIGURE D5**

**POWER STEERING FRONT MOUNTING BOLTS**

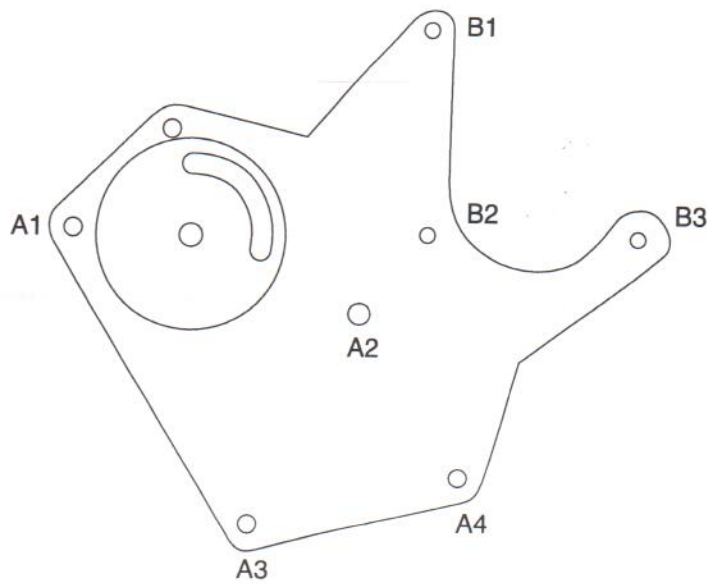

**FIGURE D6A**

**MAIN BRACKET ORIENTATION**

## **D. ENGINE ACCESSORIES AND PROCHARGER INSTALLATION**

*In this section you will install the ProCharger and connect all related oil lines and air hoses*

### **DESCRIPTION AND OPERATION**

The main components of the ProCharger system are the ProCharger, ProCharger mounting bracket, alternator bracket, and power steering bracket. The ProCharger is a gear-driven centrifugal compressor, driven by an 8 or 12 rib serpentine belt. It uses a billet aluminum impeller, super precision bearings and carburized gears. The impeller speed is dictated by engine rpm, crank pulley-to-driven pulley ratio and the final internal gear ratio. As engine speed is increased both airflow and boost (resulting from engine back-pressure) are increased. The quoted boost levels of the kit can be exceeded if the factory-set redline is surpassed. The mounting brackets are flat billet aluminum types which utilize a series of spacers to properly position the ProCharger and alternator, and relocate the power steering pump.

1. Bolt the rear power steering bracket to the port side head using the two outermost mounting holes on the head. Orient as shown in Figure D1. Use the 7/16" x 1" bolt in the lower hole and leave the upper hole vacant.
2. Remove the power steering pump from its bracket. Place .3" spacer over the lower of the two power steering mounting studs. Slide the mounting studs on the back of the power steering pump through the lower holes on the rear power steering bracket. Start the stock nuts on the studs.
3. Using the two holes on the engine block just to the right of the harmonic balancer on the port side, bolt the front power steering bracket to the engine oriented as shown in figure D2. Hole A from Figure D3 uses a 3.35" spacer between the bracket and block with a 7/16" x 4 1/2" bolt going through. Hole B uses a 3.35" spacer between the bracket and block also, but on the front of the bracket place the 10 rib idler with .70" idler bushing (1.6" O.A.L.), and run a 7/16 x 6" bolt through. When finished, the result should look like Figure D4. The two holes on the right side of the bracket should line up with the two holes on the front outside of the power steering pump as in Figure D5. Bolt the pump to the bracket using 2 supplied 10 mm bolts.
4. Orient the ProCharger main bracket as shown in figure D6. Place a 3.875" spacer between the rear power steering bracket and the main bracket at hole A2. Use the 7/16" x 5 1/2" (7/16" x 5" on SC system) bolt to bolt to the head. Start a 3/8" x 5 1/2" (3/8" x 5" on SC system) bolt through hole A3 on the main bracket, place a .55" spacer between the main bracket and the front power steering bracket, and a 3.35" spacer between the front power steering bracket and block and bolt to the engine block.
5. Run a 3/8" x 2" (3/8" x 1 3/4" on SC system) bolt through hole A4 on the main bracket, the other .55" spacer, and the front power steering bracket. Thread a 3/8" nut onto the bolt and tighten.
6. If you will be mounting your intercooler remotely, use a 7/16" x 5 1/2" (7/16" x 5" on SC system) bolt and 4.25" spacer to bolt hole A1 to the innermost head bolt hole. If you will be mounting your intercooler on the engine, bolt it to the heads as follows: orient the intercooler with the tabs at the bottom with the longer strap toward the motor. Run the 7/16" x 7" bolt through the front intercooler strap, the 1.5" (1.8" on SC system) spacer, hole A1 on the main bracket, a 2" spacer, the rear intercooler strap, and finally the other 2" spacer. Bolt all the head loosely so that the intercooler can be rotated into position on the starboard side head. Remove bolt holding the alternator bracket to the innermost head bolt hole on the starboard side. Run the 7/16" x 3 1/4" bolt through the intercooler strap, the 2.3" spacer, and alternator bracket and bolt to the head.

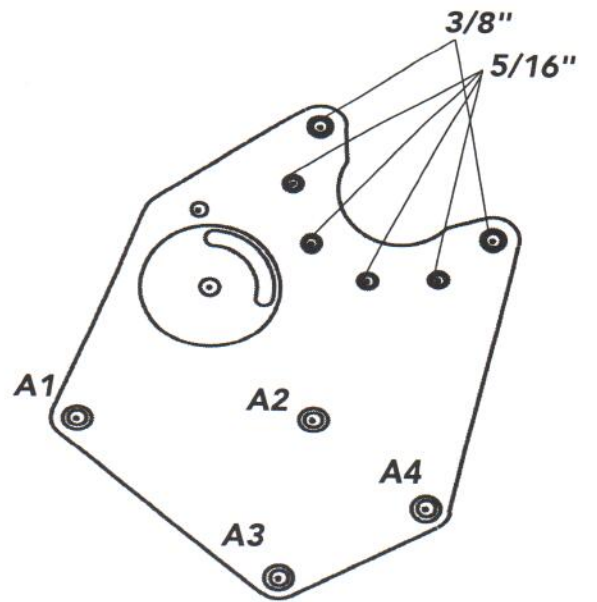
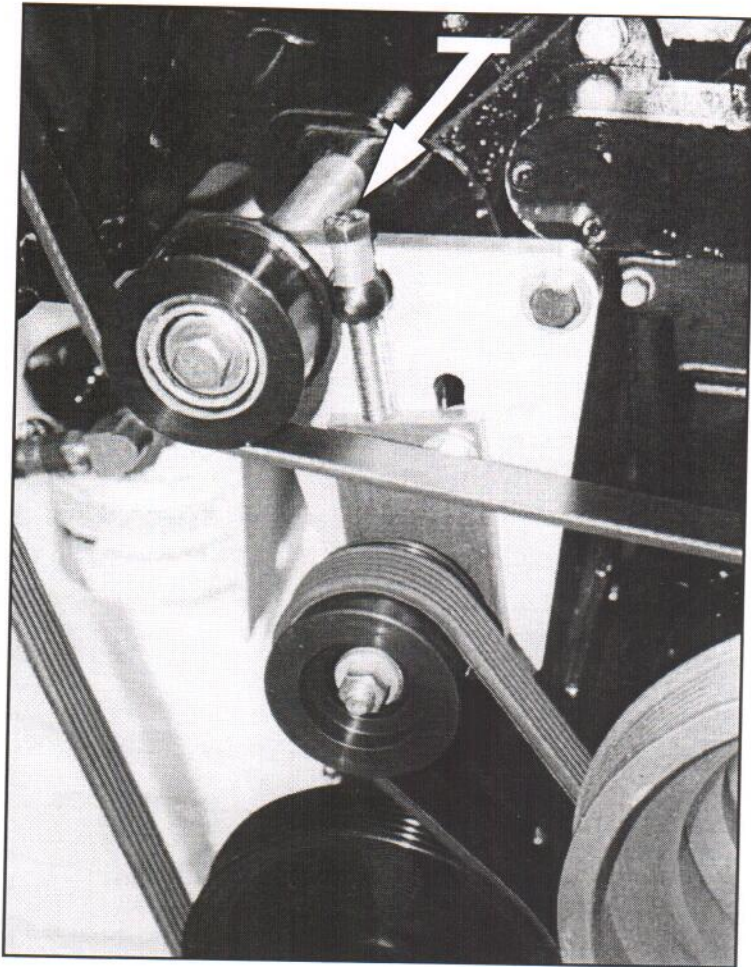

**FIGURE D6B**  
**SC BRACKET ORIENTATION**

**FIGURE D7**  
**TENSIONER BRACKET ORIENTATION**

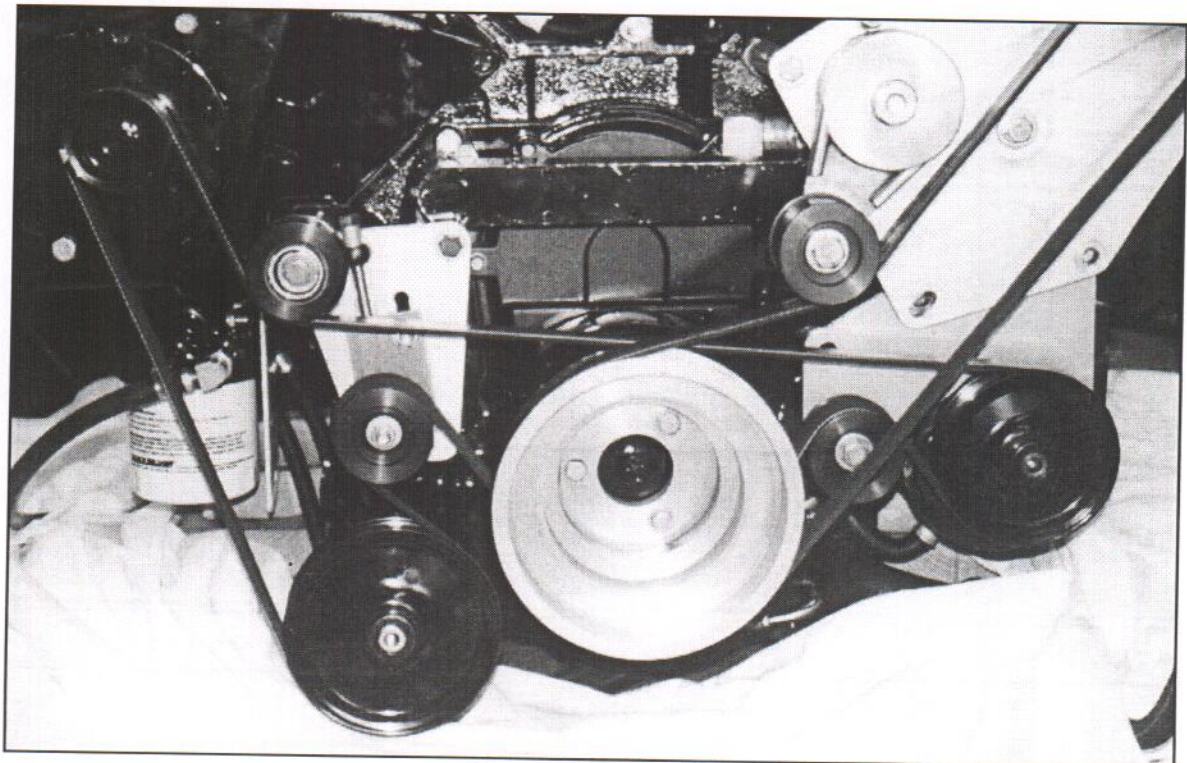
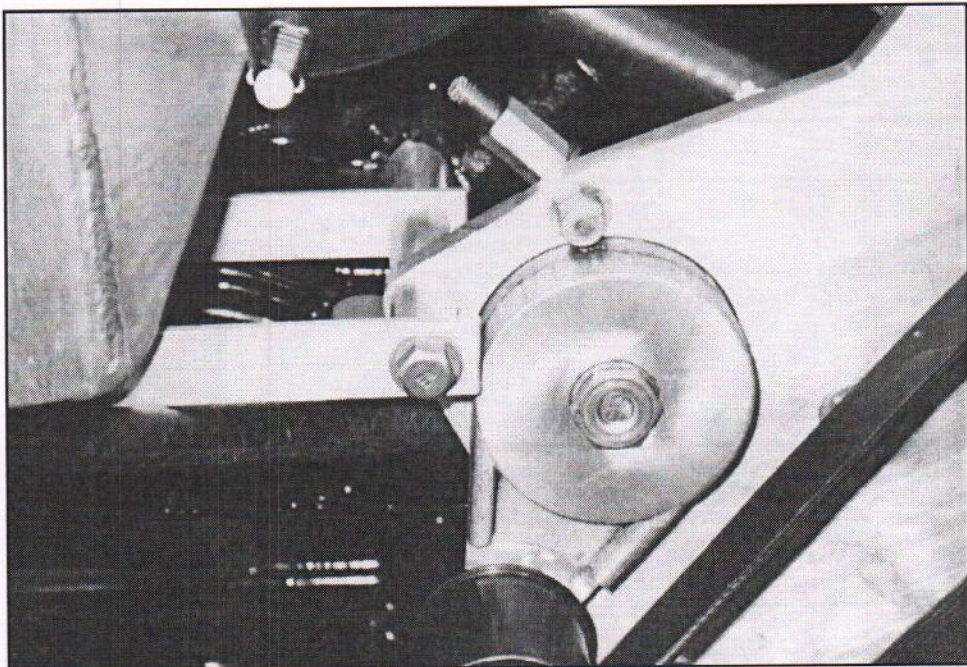

**FIGURE D8**  
**ACCESSORY BELT ROUTING**

7. At this point tighten all bolts securely including the nuts on the backside of the power steering pump. Reattach the power steering lines to the pump.
- 8a. M1: Using the supplied 5/16" x 1 1/4" bolts, and holes B1, B2, and B3 on the main bracket, attach the ProCharger to the main bracket. Connect the oil feed line to the fitting on the side of the ProCharger. Attach the oil drain line to the fitting on the pan. Clamp down. Route the oil drain line up to the ProCharger oil return fitting on the bottom of the ProCharger. Cut the line to the proper length and clamp to the oil drain fitting.

**This is a gravity feed system; the oil return line must be kink free and downhill the entire length, and should drain into the pan above the oil level line.**

- 8b. SC: Using the supplied (4) 5/16" and (2) 3/8" socket head cap screws, attach the ProCharger to the main bracket.
9. On the starboard side of the engine, take the tensioner bracket as oriented in figure D7. Using a 3/8" x 4 1/2" bolt and the 2.65" spacer, attach hole A2 to the crossover tube flange. Use the 7/16" x 4" bolt and 3.0" spacer to attach hole A3 to the lower hole in the engine block. Place the 3.1" spacer between bracket and head. Place the 10 rib idler with 1.125" bushing (2.0" O.A.L.) on the outside of the bracket and using a 7/16" x 7" bolt, attach hole A1 to the bolt hole left vacant when the stud was removed in step 12 in section A.
10. Install the new 6 rib belt as shown in figure D8. Tension by tightening the adjusting bolt (see figure D4) at the top of the mounting bracket, then tightening the bolt on the sliding tensioner bracket to keep in place.
11. Install the blower belt between the crank pulley and the ProCharger pulley with the spring tensioner on the top loop of the belt pressing down. Tighten the brass nut to tension until the line on the side of the tensioner reaches the second mark. Tighten the 1/2" bolt from the back of the bracket to clamp down.



**FIGURE D9**  
**PORT SIDE INTERCOOLER TABS MOUNTED**  
**TO MAIN BRACKET AND HEAD**

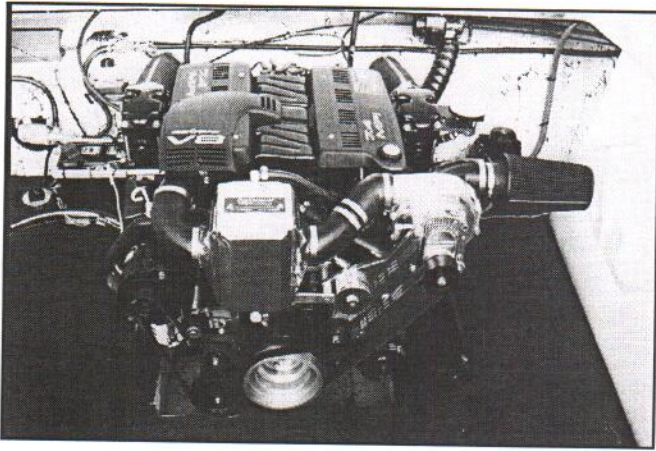

**FIGURE E1**  
**TYPICAL ENGINE MOUNT INTERCOOLER**

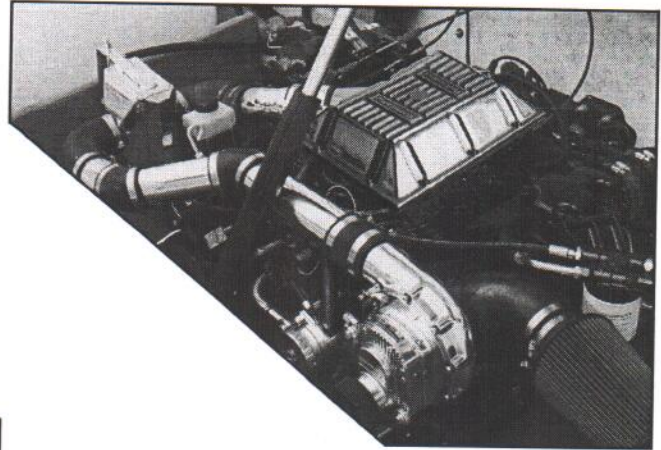

**FIGURE E2**  
**TYPICAL REMOTE MOUNT INTERCOOLER**

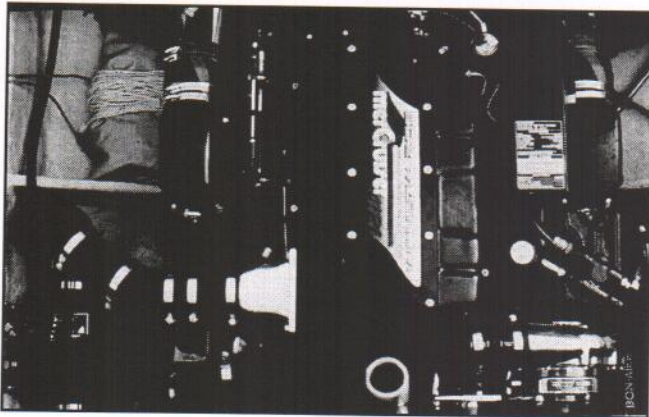

**FIGURE E3**  
**TYPICAL REMOTE MOUNT INTERCOOLER**

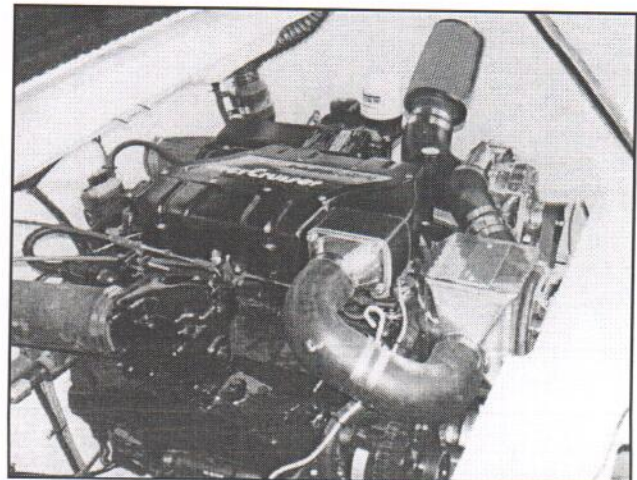

**FIGURE E4**  
**INTERCOOLER MOUNTED REMOTELY TO BACKSIDE OF REAR SEAT DUE TO TIGHT FRONTAL CLEARANCE**

## **E. AIR INLET AND INTERCOOLER TUBING INSTALLATION**

*The intercooler will either be mounted on the engine using the power steering and main bracket spacers, or remotely. If you are using the engine mounted intercooler, it should already have been installed in section D. If you are mounting the intercooler remotely, you will need to do so now with this section as a guide.*

### **DESCRIPTION AND OPERATION**

The intercooler system main components consist of the intercooler and tubing. The intercooler is a two core, plate style, air-to-water heat exchanger. The charge air (compressed and therefore heated) coming from the ProCharger enters the intercooler plenum, passes thru a series of passages and exits the opposite plenum. Water taken from the seawater pump flows through the crossflow passages in the intercooler, thereby cooling the charge air. The cooled charge air is then routed to the throttle body where it enters the intake manifold. The air inlet system uses a Coast Guard approved 9" K&N™ air filter to filter intake air.

#### **Engine mounted intercoolers:**

1. Review figure E1 before starting. Place supplied 4" inlet elbow over ProCharger inlet. Position the elbow so that it points upward and/or outward to avoid the exhaust manifold and, if applicable, deck above when the filter is installed. If necessary, this elbow can be trimmed to obtain the proper clearance. Temporarily secure with a clamp. On the inlet elbow, position and mark the location of the breather fittings (the plastic 1/2" straight and 3/8" 90 deg fittings). The fittings should be positioned so that the straight 1/2" fitting routes to the port side breather and the 3/8" 90 degree fitting routes to the starboard side breather. Remove the elbow and drill a hole for the 1/2" fitting using a 7/16" drill bit and for the 3/8" fitting using a 5/16" drill bit. Insert the fittings and re-install the inlet elbow.
  - 1a. Using the supplied 3/8" X 2 ft hoses, route the valve cover breather fittings to the inlet elbow fittings, cutting the hose to length as required.
  - 1b. Insert the 4" end of aluminum reducer into the inlet elbow and secure with a clamp. Attach the supplied K&N air filter to the 3.5" end of the reducer and secure with a clamp.
2. Insert the 3" I.D. rubber offset hose between the outlet of the ProCharger and the inlet of the intercooler. Clamp both connections securely.
3. Connect the 3" end of the 3" - 3.5" molded rubber hose to the outlet of the intercooler and rotate so that the 3.5" end can be slipped over the opening of the throttle body. Clamp both ends with hose clamps. Check all intercooler tubes and connections to insure that they are all tight and not kinked.

#### **Remote mounted intercoolers:**

1. Review figures E2-E4 before starting. Place supplied 4" inlet elbow over ProCharger inlet. Position the elbow so that it points upward and/or outward to avoid the exhaust manifold and, if applicable, deck above when the filter is installed. If necessary, this elbow can be trimmed to obtain the proper clearance. Temporarily secure with a clamp. On the inlet elbow, position and mark the location of the breather fittings (the plastic 3/8" 90 deg fittings). The fittings should be positioned so that one of the fittings routes to the port side breather and the other to the breather fitting on the throttle body. Remove the elbow and drill holes for the 3/8" fittings using a 5/16" drill bit. Insert the fittings and re-install the inlet elbow.

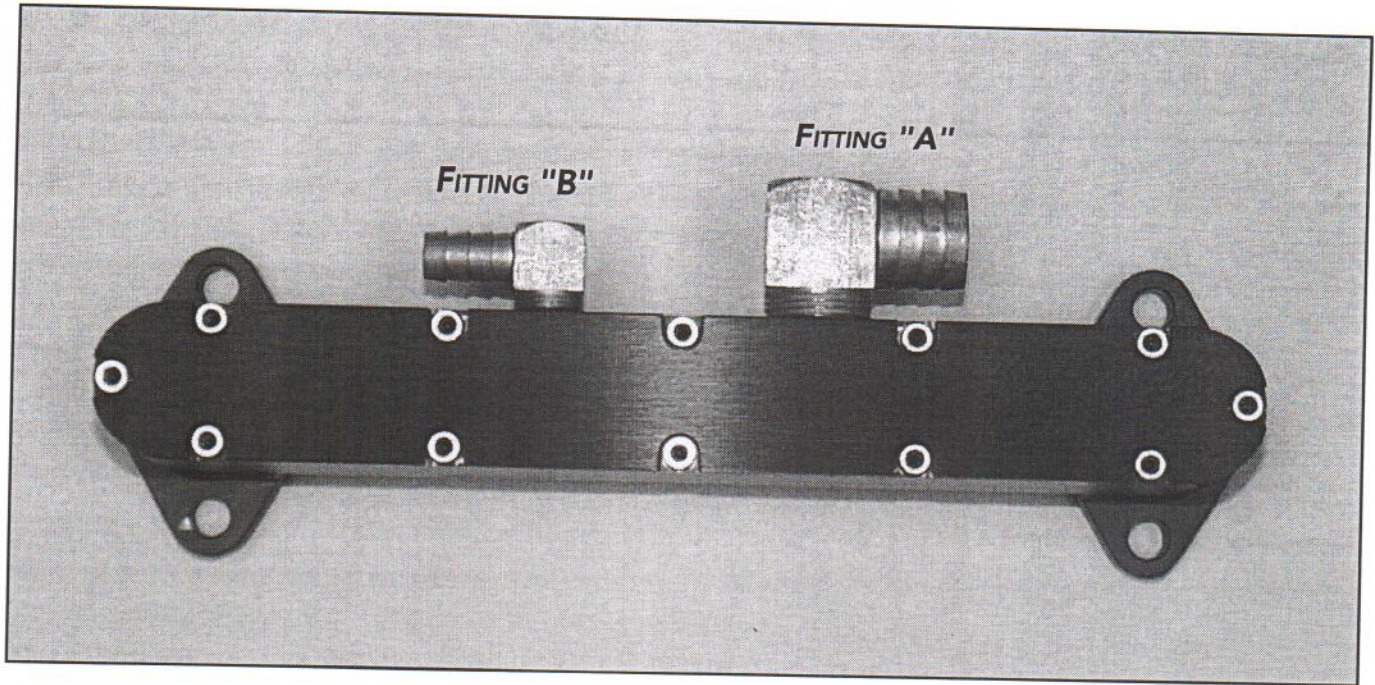

**FIGURE F1**  
**CROSSOVER TUBE/WATER TEE FITTING**

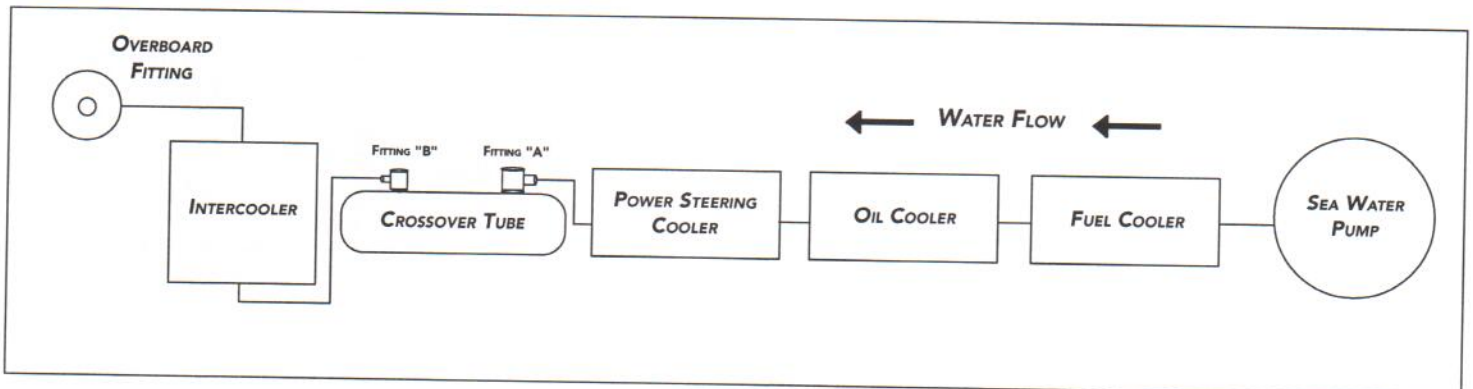

**FIGURE F2**  
**TYPICAL WATER ROUTING (NOTE: COOLER SEQUENCE WILL VARY BY BOAT)**



- 1a. Using the supplied 1/2" X 2 ft and 3/8" X 2 ft hose, route the valve cover breather fittings to the inlet elbow fittings, cutting the hose to length as required.
- 1b. Insert the 4" end of aluminum reducer into the inlet elbow and secure with a clamp. Attach the supplied K&N air filter to the 3.5" end of the reducer and secure with a clamp.
2. Determine where you are going to mount the intercooler. The intercooler has several mounting tabs attached to it. Find a place where these tabs can be used, it will be out of the way of the engine, and sits close to the level of the outlet of the ProCharger. Generally, you would like to keep it somewhat close to the engine to minimize the distance the charge air has to flow and the number of bends it has to make. Refer to figure E2 for an example. After you have determined the mounting location, bolt or screw the side tabs to the mounting surface. Included in the kit is a straight piece of strap. At the bottom of the intercooler is another tab. Bend and drill the strap so that it can be bolted to the bottom tab and to another mounting surface.
3. Your kit contains a section of 3" O.D. aluminum tubing. You will need to cut this tubing as required to make up your tubing system. After you make a cut, clean up the ends with a file or sander and flare. Flare the end by closing down a crescent wrench so that it just fits over the tubing wall. Pull out on the wrench slightly so that about 1/4" of the wall is crimped outward at about a 20° angle. Do this all the way around the tube. When done, fit a rubber connector over the end to make sure it is not flared too much. After the first one, you should get a good idea of how much flare is needed.
4. Measuring out the proper distances, use a series of straight metal tubes, rubber connectors, and rubber elbows, to run between the outlet of the ProCharger and one side of the intercooler, being sure to bend around obstructions.
5. Remove the air filter from the throttle body. Remove the four studs which hold the filter and throttle body to the manifold. Using the supplied 5/16" x 4.5" bolts, bolt the ATI throttle body flange, together with the throttle body, to the manifold.
6. Again, using a series of metal tubes, connectors, and elbows, plumb the intercooler tubing from the other side of the intercooler to the 3" end of the throttle body flange being careful to bend away from obstructions and moving parts. Clamp all connections on the system securely with the supplied hose clamps.
7. Test your intercooler system to ensure that it is rigidly mounted (it will be full of water when in operation) and does not interfere with other systems within the engine compartment.

## **F. WATER LINE INSTALLATION**

### **DESCRIPTION AND OPERATION**

The water lines established in this section allow water to be routed to and from the air-to-water intercooler. This is accomplished by routing hose to crossover tube fitting for the feed line, and installing an over board fitting for the discharge line.

1. Reattach the 1" water lines running to the exhaust to the fittings on the thermostat housing.
2. Attach supplied 1/2" hose to small barb fitting on crossover tube. Route hose away from belts and attach to lower fitting on intercooler. It is important that the water feed line for the intercooler be attached at the bottom and the discharge at the top, otherwise the intercooler will not fill up with water and will provide little cooling effect.
3. Intercooler over board fitting can be located in either two locations above the drive unit for cooling (if not using drive shower) or on driver side of hull for water flow verification through intercooler. Drill a hole to match the size of the outer diameter of the supplied overboard. Cover the outside of the fitting with silicone and slide through the hole with the barb fitting on the inside. Tighten down the nut on the fitting to secure the fitting to the hull. Attach remaining 1/2" hose to top fitting on the intercooler route hose to over board fitting and clamp securely at both ends.

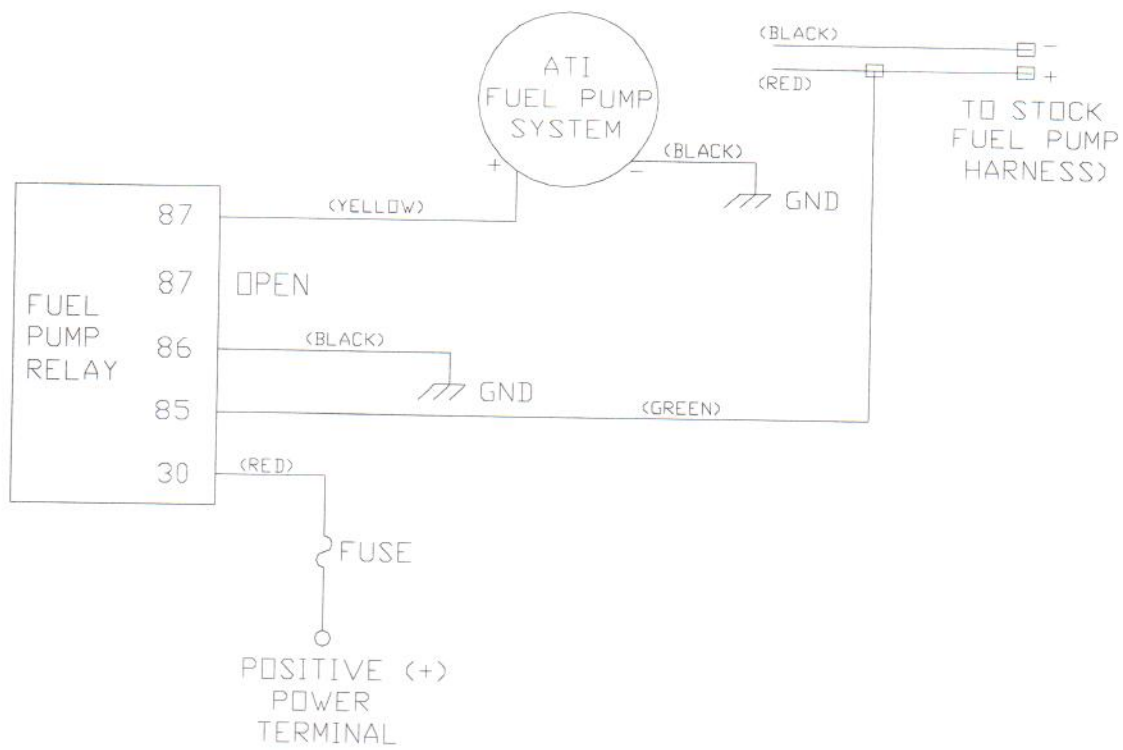

**FIGURE G1**  
**FUEL PUMP RELAY WIRING DIAGRAM**

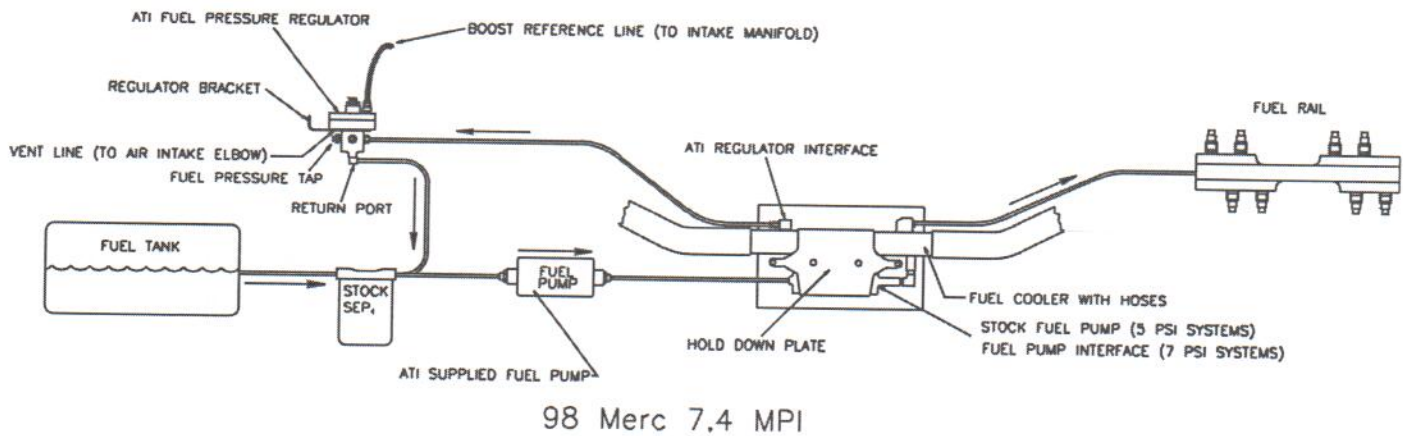

**FIGURE G2**  
**FUEL PUMP SCHEMATIC**

## G. FUEL SYSTEM INSTALLATION

### DESCRIPTION AND OPERATION

The '98 Mercruiser fuel system has a single electric fuel pump which draws fuel from the tank through the separator and pumps it through a fuel cooler to the fuel rail. Returned fuel from the fuel pressure regulator is circulated back to the separator. ATI supplies a replacement boost sensitive regulator and additional fuel pump (the 7 psi configuration supplies a replacement pump rather than an additional pump) to increase fuel pressure under boost. This pump is a vane-style pump which can produce high flows and pressures, but does not draw fuel as well as a diaphragm type pump, therefore, this pump should be mounted as low as possible in the boat (i.e. to an engine stringer or similar). From the ATI fuel pump, the fuel is pumped to the stock fuel pump (or pump interface for 7 psi), through the fuel cooler where it is tee'd to the fuel rail and ATI regulator (the stock regulator is replaced with a replacement regulator interface), then back to the separator.



**Warning/Caution:** This is a high pressure EFI fuel system. When working on the fuel system, there will be a small amount of high pressure fuel discharged when initially opening up the system. Proper precautions should be taken to contain or minimize spillage (i.e. catching fuel in a container and/or soaking up fuel in a rag) and avoid exposure to spark or flame (i.e. disconnect battery, no smoking, etc.).



**Warning/Caution:** Ensure that all fuel lines are correctly sized for the supercharged horsepower rating of the engine. This includes the anti-siphon valve, fuel filters, etc. . Please contact an ATI service technician should you have any questions.

1. If not already done, remove the stock fuel pump, cooler assembly (located adjacent to the port side engine mount) from the engine. Remove the plastic cover and metal retaining bracket.
2. Remove the fuel cooler and disconnect the fuel and vacuum lines from the stock regulator. Remove the stock regulator and screen under stock regulator and discard. Install the supplied regulator interface. Re-attach the fuel line to the regulator interface. If installing a 7 psi system, replace stock fuel pump with supplied fuel pump interface. Re-assemble fuel pump/cooler (or interface/cooler, if 7 psi) assembly (do not yet re-install).
3. Disconnect the fuel line from the water separator that runs to the inlet of the stock fuel pump. Remove the 3/8" FPT to 1/4" MPT fitting from the separator, and re-attach this fitting to the removed fuel line. Attach supplied 1/4" FPT - 3/8" barb to the fitting on the fuel line. Install the provided 1/4" MPT - 3/8" barb fitting into the fuel separator.
4. Find a spot near the fuel separator and as low as possible to mount the ATI provided fuel pump. Using the provided brackets and screws, install the fuel pump to the stringer or floor. Run the inlet line from the fuel pump to the barb fitting installed in the fuel separator in step 3. Clamp securely.



**On the ATI provided M-1 Fuel Pump the inlet end of the pump can be identified as the end without the electrical power wires. This is the only visible indicator of the inlet end.**

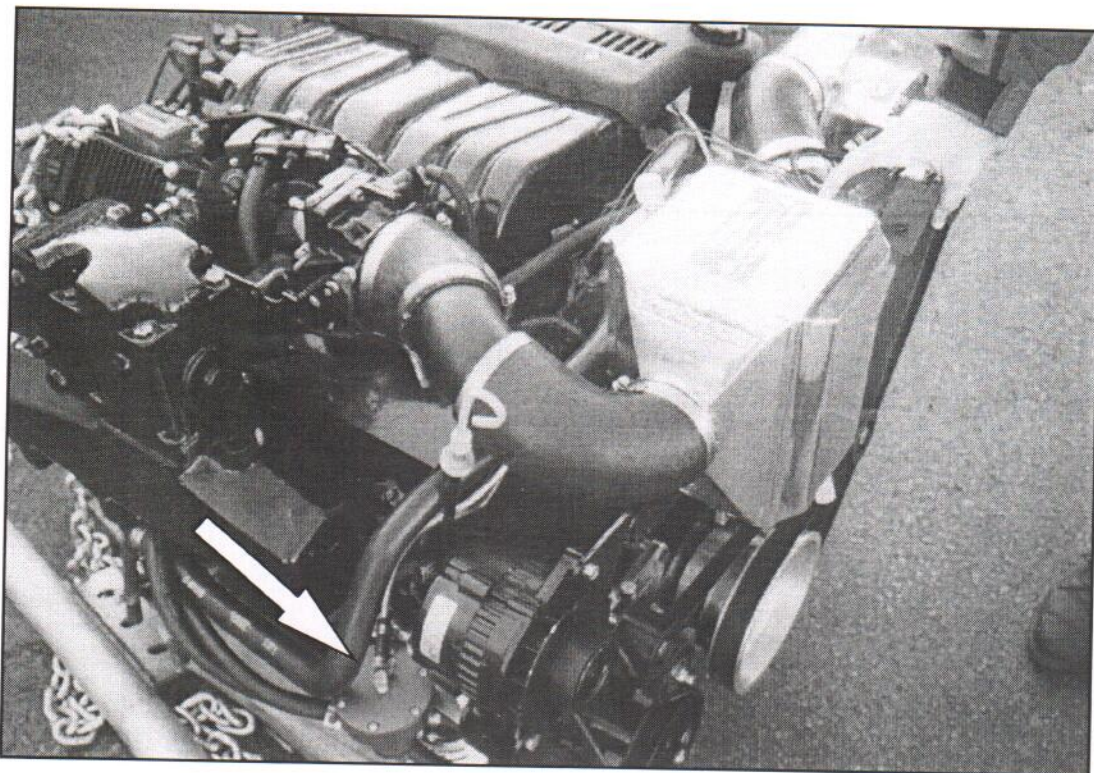

**FIGURE G3**  
**FUEL PRESSURE REGULATOR INSTALLATION**



**FIGURE H1**  
**COMPLETED ProCHARGER SYSTEM INSTALLATION**

5. Attach the fuel line running to the stock pump (or fuel pump interface, if 7 psi) to the fitting on the outlet of the ATI pump. Note: 7 psi systems will need to notch the fuel cooler mounting box and cover for the larger fuel line. Re-install fuel pump/cooler assembly (or pump interface assembly, if 7 psi).
6. Using the outermost bolt on the alternator, attach the ATI regulator with bracket to the motor. There is a second line on the separator that runs to the fuel pressure regulator interface on the fuel cooler. Unscrew the line from the fitting on the separator. Attach the line to the inlet (the port with the female inverted flare fitting) of the regulator. Attach the outlet line from the regulator (fitting on the bottom marked "ret") to the fitting on the separator. See figure G3.
7. Run the boost reference line from the top of the regulator (adjacent to the adjusting screw) to the manifold vacuum fitting previously routed to the stock fuel pressure regulator. Route the regulator vent line over near the supercharger inlet elbow. Drill or punch a 3/32" hole in the inlet elbow (between the supercharger and air filter) and install exposed end barb fitting in vent line. Although the regulator is preset at factory, fuel pressure must be checked upon completion of installation; if necessary, the regulator may be adjusted to either increase or decrease fuel pressure. See section H regarding regulator tuning.
8. Attach the positive or red lead from the ATI fuel pump to relay terminal (#87).
9. Attach the black ground wire from the relay (#86) and the negative or black lead on the fuel pump to a ground source.
10. Connect the green wire from the relay (#85) to the red wire on the stock fuel pump harness.
11. Run the red wire from the relay (#30) to the power terminal on the alternator or on the battery terminal utilizing the supplied inline fuse and ring connector.
12. Test your connections by turning the key to the "ON" position. You should hear the fuel pump(s) momentarily run. Before operating the boat, start the engine and check for fuel leaks.
13. 7 psi systems only: Remove stock fuel injectors and replace with supplied injectors.



**For 7 psi systems, ensure that you have replaced the stock fuel injectors with the larger fuel injectors supplied with 7 psi 7.4 MPI systems. Failure to do so will result in inadequate fuel delivery and possible engine damage.**

## H. INSTALLATION REVIEW AND SAFETY CHECK

1. Carefully review the entire installation (figure H1). Check oil and fuel lines near moving parts and the exhaust system to ensure that these lines are safe, secure and not twisted or kinked. All wires and hoses should be firmly secured with clamps or wire ties. Also, ensure that the inlet screen is installed on the back of the ProCharger.
2. Check all fluid levels. Your tank should be filled with **91 octane** or higher fuel before hard running. **For SC ProCharger models, you must add oil to the supercharger before operation.**
3. Start engine and idle for a few minutes. You should be running stock Mercruiser timing. Check and adjust if necessary.
4. Shut off engine and check for fluid leakage, signs of rubbing parts, and other potential problems
5. Your motor should display a significant increase in performance when you are hard into the throttle, with no detonation. If this is not so, review your installation, then contact your dealer or ATI for assistance. Mercruiser EFI engines are designed to run slightly rich for maximum reliability.



6. For best performance and reliability, **always use premium grade fuel (91 octane or higher)** and listen for signs of detonation. Back off throttle should detonation occur. With a properly installed ProCharger and appropriate timing, detonation should not be an issue.

7. Never race your engine (and ProCharger) when the engine is cold. Allow water temperature to climb into operating range before revving above 2,500 rpm.

8. Be sure you have purchased and properly installed a fuel pressure gauge and/or fuel/air ratio meter to monitor fuel delivery. Installation of a boost pressure gauge is also recommended. The fuel pressure gauge should be plumbed into the ATI fuel pressure regulator (one of the ports is already reduced down to 1/8" fpt for installation of a fuel pressure gauge). A boost gauge can be plumbed (tee'd) into any port on the intake manifold.



9. **After the system is installed, fuel pressure at idle should be checked.** The idle fuel pressure should be 40-45 psi for 5 psi systems and 30-34 psi for 7 psi systems. Under full boost conditions fuel pressure should increase to 48-54 psi. Idle fuel pressure can be adjusted by tuning the regulator. Regulator tuning is accomplished by loosening the jam nut on the regulator with a 3/4" open end wrench, and then using a 1/4" allen wrench to adjust fuel pressure. Clockwise raises fuel pressure; counterclockwise reduces pressure. Remember that leaning the fuel pressure will increase HP but can create an extremely dangerous lean condition. **Be careful and ensure that you always maintain adequate fuel pressure!** Contact ATI for special applications requiring regulator modifications for higher rates of gain.

10. Mercruiser EFI/MPI rev limiters cut off fuel to limit rpm, which can cause a dangerous lean condition. Ensure that boat is propped so that maximum rpm is below factory rev limiter. **Repeatedly bumping/riding rev limiter can result in serious engine damage.**



11. It is very important that all fuel lines are sized according to the supercharged horsepower rating of the engine. This includes the anti-siphon valve, fuel filters, etc. Please contact an ATI service technician should you have any questions.



12. Review the maintenance and warranty sections within this owner's manual.

# TUNING

## **Fuel Pressure**

**On a fuel injected motor, adequate fuel pressure is the most important factor in maintaining the correct fuel-air ratio.** When supercharging a fuel injected motor, extra fuel beyond that supplied by the Mercruiser computer and fuel system is required, due to the extra oxygen in the cylinder. This extra fuel is provided by increasing the fuel pressure when under boost. After the system is installed, fuel pressure should be checked. Refer to section H. for fuel pressure specifications and adjustments. It is extremely important to check the pressure as the motor may run seemingly fine, but due to insufficient pressure is running dangerously lean. Fuel pressure can be increased or decreased by adjusting the regulator. If your engine is not completely stock, check with ATI for fuel pressure recommendations prior to operation.

## **Timing**

All motors may require subtly different timing for best tuning. However, as most motors are close to the same, we can give general guidelines. Most medium sized V Hulls, twin engine applications, and generally boats with 1.50 gear ratios or more (lower) that are able to plane with relative ease in a tall propped, high speed setup, will generally not need as much initial timing. Dyno results have shown that most moderate compression GM BB's, such as Mercruiser types will not show significant variances in peak HP if total timing is between 29-32°. However, in the previously mentioned boat types which exhibit good planing & driveability characteristics, backing the timing down from the 32° Merc. Stock setting can provide some additional margin for error in the event the boat is operated with insufficient octane fuel and/or other abuses. Large single engine boats, high speed tunnel cats, and other high performance and/or 1.36 geared boats may benefit from the more advanced Merc. total 32° specification, since this will essentially increase on-plane torque due to non-aggressive low RPM tuning. Although this aggressive timing will not allow as great a margin of error at WOT, this should not pose a problem, due to the fact that these high performance applications are only capable of short bursts of full throttle operation due to water speed and general safety conditions. Obviously, the manner in which the desired timing is set will ultimately influence the final jetting or fuel pressure.

## **Plugs**

As to reading the plugs, the following information should help identify what to look for: What we want to focus on is the threads. The threads are directly connected to the cylinder, and so when the plug is removed, essentially part of the combustion chamber is removed. On almost all cases the appearance of the top of the plug threads is also what the chamber and pistons look like. We want the threads and the chamber to be black and have soot deposits. This indicates a rich supercharged condition and therefore would mean cooler exhaust temperatures. The negative ground should be clean and show no signs of blue discoloration. The electrode should be clean and white; this indicates good combustion. The following are signs of problems: If the negative ground is discolored, it indicates high temperatures. If the electrode is fuel soaked or black this indicates a misfire or fouled plug condition. If any of the 1st thread is not completely black, there is not enough fuel in the cylinder. Even if only a small part of the thread's circumference is clean, this condition may produce excellent power, but will probably produce excessive cylinder temperatures.

## **CHECKING YOUR EGT'S AND/OR READING YOUR PLUGS IS EXTREMELY IMPORTANT!**

Many activities that are good for you are usually not too enjoyable. Fortunately, when it comes to your marine engine, the simple process of monitoring your exhaust gas temperatures (EGT's) or reading your plugs can save thousands of dollars of unnecessary engine repairs and provide many enjoyable hours of trouble free service.

Monitoring EGT's requires the installation of EGT probes and gauges. If you are not familiar with this process, contact your dealer or an ATI service technician. Reading your plugs is a relatively simple alternative to monitoring EGT's, but is not as precise.

As for reading plugs, we must first start by saying that **when** a plug is read is as important as **what** is observed. If a spark plug is removed & read at the wrong time, not only will a misdiagnosis occur, but in many cases the tuner may actually mistakenly tune the engine in the wrong direction and unintentionally create a lean engine-damaging condition. Therefore, the only real way to read plugs is to remove the spark plugs immediately following a wide open throttle, full power condition. This is done by accelerating the boat at wide open throttle to full operating range for a few seconds, or until it is clear that rapid acceleration has ceased ( in most marine engines a good plug reading can be taken from 4500 to 5500 rpm) and then immediately shutting off engine and coasting to a stop. Although many spark plugs may only require less than 60 seconds each to be read & completely reinstalled, this previously described simple process provides a tremendous opportunity to literally take a snapshot of the combustion process and what is happening inside the engine.

If a hundred engine builders were asked to estimate what it would require to properly tune your engine there may be a hundred different answers since no two engines are exactly alike. It is called the cumulative tolerances theorem, a half a percent difference in total valve lift, a slight variance in piston ring gap, a small amount of unremoved casting flashing in a cooling passageway, and hundreds of other minute differences can lead to identical engines requiring some differences in fuel pressure to produce proper and uniform combustion. To properly read a spark plug we must first have the correct spark plug. Most Champion, AC & other GM spark plugs are easy to read; however, many Ford Motorcraft are black in color & therefore difficult to read. It is suggested for best results that a brand new set of spark plugs be installed before any attempts to gather information. Let us remind you the following tuning tips are based on unleaded pump gas operations in the stock compression ratio range. Since today's pump fuels register significantly lower octane ratings, and therefore are significantly more susceptible to engine knock or ping, than yesterdays high octane fuels, it is important that some additional fuel be placed in the cylinder - not intended to be burned, but just to act as a cooling medium. This simply means that a richer than "ideal" air fuel ratio is now highly desired for maximum performance on todays pump gas engines. After the system is installed, fuel pressure should be checked. Refer to section H. for specifications and adjustments. It is extremely important to check the fuel pressure as the motor may run seemingly fine, but due to insufficient pressure is running dangerously lean. Remember that leaning the fuel pressure will increase HP but can create an extremely dangerous lean condition. Contact ATI for special applications requiring regulators with higher rates of gain.



# OPERATION AND MAINTENANCE

- **COLD STARTING**

Never race your engine (and ProCharger) when your engine is cold. Allow the water temperature to climb into operating range before revving above 2,500 rpm.

- **FUEL QUALITY**

For best performance and reliability, **always use at least 91 octane fuel**. Always listen for signs of detonation after refueling, and after replacement or modification of any fuel system components. Back off throttle should detonation occur. With a properly installed ProCharger intercooled supercharger system, detonation should not be an issue

- **OIL AND FILTER MAINTENANCE**

M1 only: Always change your oil and filter every 25-30 hours. Delaying your oil change beyond the recommended interval risks the health of both your high performance engine and ProCharger. M-1SC and M-3SC models, See SC applications page for SC oil change intervals.

- **IGNITION SYSTEM MAINTENANCE**

If your spark plugs are more than two years old or have more than 100 hours use, you should change your plugs before operating your boat under load. Additionally, spark plug wires should be changed every 200 hours of use, or whenever resistance exceeds factory specifications.

- **AIR INLET**

**Your motor and ProCharger should never be run without an air inlet screen!**

- **BELT TENSIONING AND REPLACEMENT**

The belt which turns your ProCharger will stretch after initial run-in, and may need retightening after the first few hours, if not sooner. After possibly one more tightening of the belt with the tensioner, further stretching should not occur. Tighten the belt sufficiently to avoid slippage, but do not overtighten, as this could cause damage to the ProCharger's precision bearings. Should you throw a belt and find that it needs constant retightening, the belt is damaged and should be replaced. 8-rib belts can be bought from ATI or your local parts store. Gates Micro-V belts are recommended; these belts are available at CarQuest™, NAPA™ and other auto parts stores. Your nearest CarQuest store can be found by dialing 800-492-7278, the nearest NAPA store at 800-538-6272.

- **IMPELLER SPEED**

Maximum impeller speed should not exceed the redline stated for each model in the table below. Maximum impeller speed = crankshaft pulley diameter (N1) divided by supercharger pulley diameter (N2), multiplied by the step-up ratio stated in the table, multiplied by engine rpm at redline.

$$\text{Impeller RPM} = (N1/N2) \times (3.05, 4.10 \text{ or } 4.44) \times \text{engine RPM}$$

Model:	M1B	M1	M1SC	M2	M3SC	M3	M4
RPM (MAX):	54,000	50,000	57,000	59,000	50,000	53,000	50,000
Step-Up Ratio:	3.05:1	3.05:1	4.10:1	4.44:1	4.10:1	4.44:1	4.44:1

**If you require technical support, please contact us at (913) 338-3086 9:00-5:00 CST Monday - Friday, or contact technical services via email at [techserv@procharger.com](mailto:techserv@procharger.com)**

# SC APPLICATIONS

- **WARNING:**



**ALL SC SUPERCHARGERS CONTAIN NO OIL FROM THE FACTORY. YOU MUST ADD THE SUPPLIED PROCHARGER OIL PRIOR TO USE.**

Use only ATI supplied oil in your SC ProCharger. The ATI oil has been specially formulated for the bearings in the ProCharger and use of oil other than that supplied by ATI will void your warranty.

- **OIL CHANGE INTERVALS**

The first oil change should be performed at 15 hours and at 100 hour intervals thereafter. Clean drain plug after every oil change. Drain oil by removing the magnetic drain plug. Clean off the magnetic drain plug before reinstalling. *See figure below, left*

- **OIL LEVEL**

The oil level must be checked periodically (when cold) to ensure the proper oil level in the ProCharger. The dipstick can be loosened using a flat blade screwdriver or a coin. When installed, the oil level should be between the min and max levels (See fig. below). If the oil level falls below min, fill the ProCharger, through the dipstick hole, until the proper oil level is reached. **Warning: Filling the ProCharger higher than the "max" level on the dipstick will lead to bearing and/or seal damage.** The SC ProChargers are sealed units and normally will not require the addition of oil between service intervals. If excessive consumption is noted, the unit should be sent to ATI for inspection/repair. Disassembly of the supercharger will void your warranty.

- **GENERAL**

When removing the dipstick, be sure to retain the nylon washer. A spare washer is provided with each box of SC oil (a box is included with each system). Do not remove or replace either the nylon washer on the dipstick, or the rubber o-ring on the drain plug with anything other than ATI supplied replacements. **Evidence of either case may void factory warranty.** A discoloration of the oil and residue on the drain plug will be noticed during initial oil changes. This is no cause for concern and will eventually diminish. The serial tag on your SC ProCharger must be pointing upwards for proper orientation. Installing the supercharger in another orientation will result in inadequate oiling and supercharger failure. If you have any questions about the maintenance of your SC ProCharger they should be directed to an ATI service technician or dealer.



SEALED PLUG  
(SOCKET HEAD)

MAGNETIC  
DRAIN PLUG  
(HEX HEAD)



SEALED PLUG  
(SOCKET HEAD)

DIPSTICK  
(FLAT HEAD)

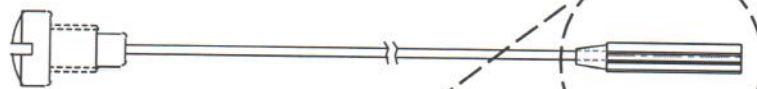

## **THE PROCHARGER® AND PROCHARGER INSTALLATION SYSTEM LIMITED WARRANTY**

Accessible Technologies, Inc. ("ATI") is proud to offer a twelve month limited warranty on its ProCharger supercharger systems and a thirty-six month limited warranty on oil-fed ProChargers (supercharger only) ordered with a 5 psi (or less) pulley. ATI's warranty obligations are limited to the terms set below:

ATI warrants the ProCharger and ProCharger installation system (together "product") against defects in materials and workmanship for a period of TWELVE (12) months from the date of original purchase from your local dealer, or date of shipment from the factory if purchased directly from ATI. If the product is used in its intended manner, ATI will repair or replace any component found to be defective at no charge to the customer. **SHOULD THE CONSUMER ELECT TO USE A DRIVEN PULLEY OTHER THAN THE ORIGINAL PULLEY SHIPPED WITH THE SYSTEM, THIS LIMITED WARRANTY IS VOID.** This warranty coverage is extended only to the original consumer purchaser, and excludes hoses, sleeves and electronic support components manufactured by other companies.

To obtain service under this warranty you must do the following during the warranty period:

1. Phone ATI (913-338-3086) and provide us with the following information:
  - ProCharger serial number
  - vehicle year, make, model, engine modifications and other modifications
  - description of perceived problem
2. If no resolution to your problem can be found after the above phone conversation, you will be assigned a warranty claim number. You must then properly ship your product, at your expense, to the ATI factory. The product should be carefully packaged in a rugged box so that none of the components being shipped could strike each other or the side of the box during shipping. The box should be strong enough to safely contain the weight of the components being shipped.
3. Include the following information inside the box with your product:
  - copy of your original invoice or receipt
  - name, address and daytime telephone number
  - warranty claim number
  - vehicle year, make, model, engine modifications and other modifications
  - description of perceived problem
4. Clearly mark the warranty claim number on the top and one side of the box in characters no less than 2" tall. Ship the properly packaged product, prepaid and insured for the retail value of the component(s) being returned, to the following address:  
Accessible Technologies, 14801 West 114th Terrace, Lenexa, Kansas 66215.

ATI agrees to honor a warranty claim at its sole discretion and only after inspection by engineers at the ATI factory. No warranty will be honored if any product subassembly is found to have been improperly installed, tampered with, mishandled or misused in any way. **DISASSEMBLY OF THE PROCHARGER OR REMOVAL OF THE PROCHARGER SERIAL PLATE VOIDS ALL WARRANTIES.** Claims for freight damages should be directed to the freight company.

If ATI's limited warranty applies, your product will be repaired or replaced at ATI's option and shipped back to you, freight prepaid, via 2nd day FEDEX service. If the limited warranty does not apply, we will advise you of the specific reason for denial, and advise you of repair expense and time. After advising you of this information we will, at your option, either proceed with repairs or return your product to you in the state in which it was received. In either case the product will be shipped to you COD, insured at replacement value. This means that you would pay the return shipping and insurance charges if ATI's limited warranty does not apply to your product.

THE WARRANTY AND REMEDIES SET FORTH ABOVE ARE EXCLUSIVE AND IN LIEU OF ALL OTHERS, WHETHER ORAL OR WRITTEN, EXPRESSED OR IMPLIED. THE DURATION OF ANY AND ALL WARRANTIES ON THE PRODUCTS DISCUSSED ARE LIMITED TO TWELVE OR THIRTY-SIX MONTHS AS STATED ABOVE. ATI IS NOT RESPONSIBLE IN ANY EVENT FOR DIRECT, SPECIAL, INCIDENTAL OR CONSEQUENTIAL DAMAGES. No ATI dealer, agent, or employee is authorized to make any modification, extension, or addition to this warranty.

# **THE PROCHARGER SC**

## **EXTENDED COVERAGE PROGRAM**

### **DESCRIPTION**

- The ProCharger Extended Coverage Program extends the warranty coverage for your M-1SC or M-3SC ProCharger an additional TWENTY-FOUR (24) months, for a total of thirty-six months. This extended coverage applies to parts and labor for the ProCharger centrifugal supercharger unit only, and does not include other system components.
- Under the extended coverage program, ATI will repair or replace any component within the ProCharger which is found to be defective.
- Service under the extended coverage program is obtained through the same process as described in The ProCharger Twelve Month Limited Warranty.

### **QUALIFICATION**

- Only the original consumer purchaser of the ProCharger is eligible, so long as this purchaser qualifies under the terms described below.
- Completion of the Extended Coverage Registration Form is required, along with a \$49 registration fee. In return for the \$49 registration fee, your system record will be updated to reflect the extended warranty and you will receive (6) additional bottles of ATI SC oil. This form must be completed in its entirety, and must be submitted along with payment within 30 days from the date of original purchase from your local dealer, or date of shipment from the factory if purchased directly from ATI.
- **PARTICIPANTS MUST HAVE ORDERED THE PROCHARGER WITH AN 8 RIB DRIVE SYSTEM WITH THE 5 PSI (OR LESS) PULLEY**, and must agree to maintain this original pulley, and not remove this pulley or disassemble or modify the ProCharger unit in any manner. With respect to the ProCharger itself, all terms and conditions within the ProCharger Twelve-Month Limited Warranty apply. Tampering with the driven pulley and any other modification of the ProCharger unit will disqualify an owner from participating in the Extended Coverage Program. Acts resulting in disqualification include but are not limited to the following:
  - Removal or attempted removal of the ProCharger driven pulley
  - Removal or attempted removal of the ProCharger serial plate
  - Removal or attempted removal of the compressor housing or transmission case
- **PARTICIPANTS MUST AGREE TO PROPERLY MAINTAIN THE PROCHARGER, AND PROVIDE PROOF OF COMPLIANCE WITH THE FOLLOWING REQUIRED MAINTENANCE:**
  - Only ATI supplied oil must be used in the ProCharger.
  - ProCharger oil level must always remain within the specified limits.
  - ProCharger oil change every 100 hours using the ATI supplied oil. (After initial oil change at 15 hours)
  - See special notes on SC applications page.

# PROCHARGER® SC EXTENDED COVERAGE PROGRAM REGISTRATION FORM

(MUST BE RETURNED WITHIN 30 DAYS OF PURCHASE WITH \$49 CHECK)

Name: \_\_\_\_\_

Date of Purchase: \_\_\_\_\_

Address: \_\_\_\_\_

Purchased From: \_\_\_\_\_

City: \_\_\_\_\_

ProCharger Serial #: \_\_\_\_\_

State: \_\_\_\_\_ Zip: \_\_\_\_\_

Boat Year: \_\_\_\_\_

Daytime Phone: \_\_\_\_\_

Boat Make: \_\_\_\_\_

Evening Phone: \_\_\_\_\_

Boat Model: \_\_\_\_\_

Which information sources most influenced your decision to purchase a ProCharger system? Please rank in order of importance (1 = most important, 2 = second most important, etc.).

- \_\_\_ Magazine advertising
- \_\_\_ Dealer recommendation
- \_\_\_ ProCharger Brochures
- \_\_\_ Witnessed performance on a car
- \_\_\_ Test drive
- \_\_\_ Magazine editorials
- \_\_\_ Friends
- \_\_\_ Conversations with ATI technicians
- \_\_\_ Web Site (please specify) \_\_\_\_\_
- \_\_\_ Other (please specify) \_\_\_\_\_

What magazines do you read?

- Boating
- Family & Performance Boating
- Hot Boat
- Power & MotorYacht
- PowerBoat
- Sport Truck
- Street Truck
- Trailer Boats
- Truckin'
- Truck Trends

What issues most influenced your decision to purchase a ProCharger system? Please rank the following issues in order of importance.

- \_\_\_ Reliability
- \_\_\_ Standard warranty
- \_\_\_ Extended coverage warranty
- \_\_\_ Performance
- \_\_\_ Quiet operation
- \_\_\_ Removability (ability to return car to stock)
- \_\_\_ Cost
- \_\_\_ Ease of installation

(Optional)  
Age  18 - 24  25 - 34  35 - 44  
 45 - 54  55 and up

(Optional)  
Income  \$15,000 - \$29,000  \$30,000 - \$44,000  
 \$45,000 - \$69,000  \$70,000 - \$99,000  
 \$100,000 and up

Who installed your ProCharger system?  Dealer  Self  Other

Have you owned a forced induction system previously?  Yes  No

Supercharger: Brand(s) \_\_\_\_\_ Vehicle(s) \_\_\_\_\_  
Turbocharger: Brand(s) \_\_\_\_\_ Vehicle(s) \_\_\_\_\_

I have read and understand the terms and qualifications for the ProCharger Extended Coverage Program. I have not modified my ProCharger in any way and will not during my participation in the extended coverage program. I have read and answered all questions on this form. I have also enclosed my check for \$49, payable to ATI, for enrolling my ProCharger (serial # indicated above) in the extended coverage program for an additional 24 months beyond the standard limited warranty period of 12 months.

Signature: \_\_\_\_\_ Date: \_\_\_\_\_

Please mail completed registration form to ATI at: 14801 West 114th Terrace, Lenexa, KS 66215.  
If you have any questions, please contact us at (913) 338-3086 9:00-5:00 CST, Monday - Friday  
Or, contact technical services via email at techserv@procharger.com

cut along dotted line

cut along dotted line

